



MECO OMAHA CANTILEVER RACK

SERIES 1000 THROUGH SERIES 5000



MECO OMAHA CANTILEVER RACK FOR A NEAT AND ORDERLY INVENTORY SYSTEM

- INSTANT ACCESSIBILITY TO ONE PIECE OR A FULL LOAD
- FAST, CONVENIENT HANDLING OF LONG, UNWILDEY STOCK

FOR STORAGE AND EASY SELECTION OF BAR STOCK, PIPE, STRUCTURALS, TUBING AND OTHER LONG ITEMS OR WHERE UNINTERRUPTED DECKING IS REQUIRED.

MECO OMAHA manufactures five basic capacity series to fit your storage requirements – from Series 1000 Medium Duty through the Series 5000 Extra Heavy Duty.

Available in upright heights from 6' to 20' with 2' through 10' brace widths (measured on center). Arms are completely adjustable on 3" centers to accommodate an infinite variety of items. Straight arms are available in nine different lengths with or without lips. Heavy Duty and Extra Heavy Duty arms are both available in seven lengths with or without lips. Inclined arms are available in seven lengths with or without lips. A wide range of base sizes allows custom designing of rack systems to your individual needs. Uprights are punched on both sides for versatility. They can be used single sided or double sided depending on the base used. Note that arms must never be placed on the back side of a single-based upright.

MECO OMAHA CANTILEVER RACKS are modular within each basic capacity series so that additional arms, uprights and cross braces may be ordered at any time to add to your existing system. Different sized arms may be interchanged on racks to further tailor your racks to different uses. Standard and Heavy Duty arms (page 28) are designed for use on Series 3000, Series 4000 and Series 5000 uprights only. Series 1000 and Series 2000 components are not interchangeable with any other rack series.

Single sided uprights can be converted to doubles when used with longer bases designed to accommodate placement of arms on both sides. Upright capacities can be computed by multiplying the number of arms per upright by the individual arm capacities—NOT TO EXCEED TOTAL UPRIGHT CAPACITIES LISTED. Arm capacity is based on EVEN DISTRIBUTION OF LOAD. All racks are designed for quick assembly and come with complete instructions and hardware for installation.

Completely adjustable MECO OMAHA CANTILEVER RACKS eliminate storage problems. Heavy duty steel construction permits storage of tubes, bars, structurals and other long heavy items that must be kept off the floor. Bases can be used for extra storage. Forklift easily loads off and on arms and bases. Fast, convenient handling of heavy, long unwieldy stock. Instant accessibility to one piece or a full load. For longer materials, simply add braces and uprights to fit your requirements.

Specially designed MECO OMAHA CANTILEVER RACK systems may be required to meet your needs. MECO OMAHA representatives will work with you to develop the most feasible and economical rack system for your special situation. Special labeling requirements can be met at an additional cost. Ask us to quote prices and specifications for rack systems not covered in the MECO OMAHA BUYER'S GUIDE.

DETAILED SPECIFICATIONS ARE SET FORTH ON THE FOLLOWING PAGES		
DESCRIPTION	UPRIGHT HEIGHTS	PAGE NO.
Series 1000 Medium Duty	6', 7', 8', 10', 12'	24
Series 2000 Medium-Heavy Duty	6', 8', 10', 12', 14', 16', 18', 20'	25
Series 3000 Heavy Duty	6', 8', 10', 12', 14', 15', 16', 18', 20'	26
Series 4000 Standard Heavy Duty	6', 8', 10', 12', 14', 15', 16', 18', 20'	27
Series 5000 Extra Heavy Duty	10', 12', 14', 15', 16', 18', 20'	28
Series 1000 Starter and Add-on Units	6', 8', 10'	29
Series 4000 Starter and Add-on Units	8', 10', 12'	29

Standard color for all cantilever rack components is gray. Custom colors available at additional cost.

WHAT IS CANTILEVER RACK?

Cantilever Rack is a freestanding storage unit with horizontal load carrying arms extending outward from a single vertical column. The absence of a vertical support on the outboard ends of the arms permits uninterrupted storage of long lengths of material.

Cantilever Rack is the **ideal system for storing furniture, steel bars, pipe and tubing, lumber and other long, heavy items** that must be kept off the floor...provides instant accessibility to one piece or a full load. Forklift easily loads off and on arms and bases. Being modular in nature, additional arms, uprights and braces may be added as storage requirements change.

Cantilever Rack is comprised of four components:

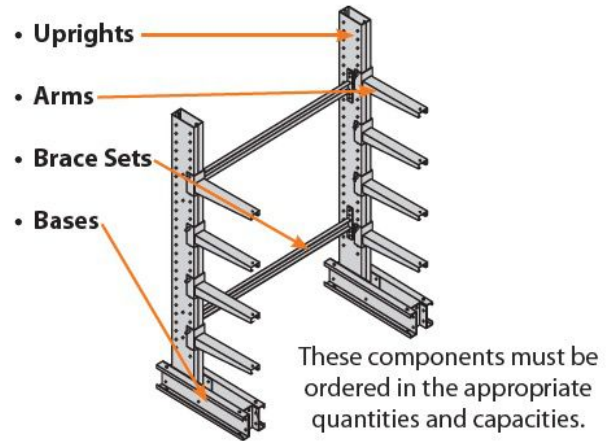

UPRIGHTS

Uprights consist of a vertical column and a horizontal base which is bolted to the column. A minimum of two uprights must be ordered to form a storage bay. Each edge of the column is punched vertically on 3" centers so it may be used as

a single or double sided upright depending on the base used. **NOTE:** The arms must never be placed on the back side of a single sided upright and base. Standard upright and base color is gray.

Single Sided Upright

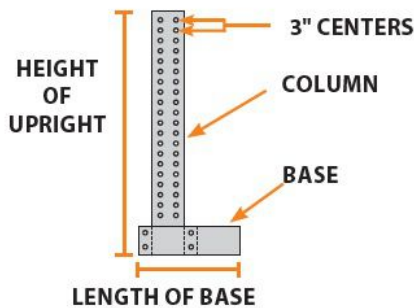

Holes are provided in the base to anchor the upright to the floor. Uprights must never be attached to walls, columns or other structures. Anchors are not provided by MECO.

Double Sided Upright

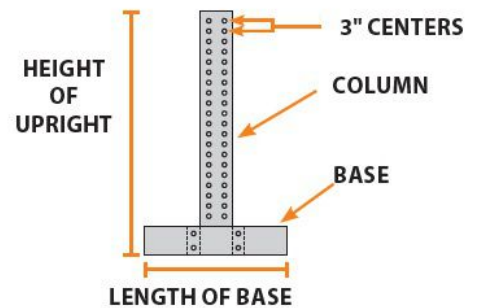

ARMS

Cantilever Arms are the heart of the rack system. Proper selection can make or break a successful storage plan. **MECO OMAHA** offers straight arms (generally used for storing stable loads such as lumber, steel sheets, cartons and skids) and inclined arms (for cylindrical objects or loads that tend to roll forward). Arms can be adjusted

on 3" centers up and down the upright and are available in lengths from 12" to 60" in a variety of capacities. The hair pin keeper permits instant adjustability and is easily inserted and removed for adjustment of arm height. Lips are available on all **MECO OMAHA** arms. Standard arm color is gray.



Straight Arm

Straight arms up to 48" long have a minimum pitch of 3/8" per foot to compensate for deflection. 54" and 60" arms have a minimum pitch of 5/8" per foot.

Inclined Arm

Inclined arms have a pitch of 20° or approximately 4.36" per foot.



MECO OMAHA
Hair Pin Keeper

BRACE SETS

Braces are structural channel members that are bolted between pairs of uprights to provide lateral stability to the rack system. X-bracing is utilized to increase the lateral stability of the taller (15' to 20') uprights. Brace

lengths are measured from centerline of upright to centerline of the next upright and are sold in sets rather than individual pieces. Standard brace color is gray.

Standard MECO OMAHA Brace Patterns

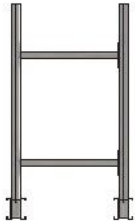

"2B" Horizontal Brace Pattern
Used on 6' to 8' uprights.

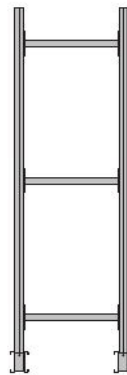

"3B" Horizontal Brace Pattern
Used on 10' to 14' uprights.

"4BX" Horizontal Brace Pattern
Used on 15' to 20' uprights.

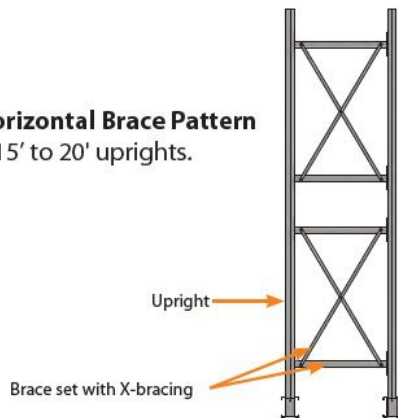

"4BXX" Horizontal Brace Pattern
Used on 15' to 20' uprights when the brace length exceeds 84" centerline to centerline of upright.

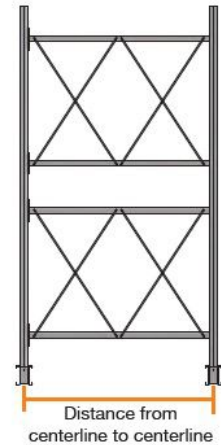

MECO OMAHA cantilever rack application consisting of uprights, arms and braces.

Standard color for all cantilever rack components is gray. Custom colors available at additional cost.

DESIGNING A CANTILEVER RACK SYSTEM

The key to a successful cantilever rack system is the answer to one question: **What is the product (load) being stored?** The answer must include the **length, depth, height** and

weight of the product. Once this data is ascertained it becomes a simple matter to determine the required arms, uprights and braces.

A. DETERMINE THE NUMBER AND SPACING OF ARMS

The load must be supported by enough arms to prevent load deflection. Deflection may cause damage to the load being stored as well as the arms (figure A1). To detect deflection, place the load over two wooden blocks (to represent cantilever arms) as shown in figure A2. If deflection is not present, it is acceptable to use a two arm system as long as this does not create an overload

condition. If the load shows deflection use three blocks as shown in figure A3 or four blocks as in figure A4.

IMPORTANT: The load should overhang the end arms by one-half the distance from upright centerline to upright centerline. Failure to observe this measure may cause an overload condition on the arms.

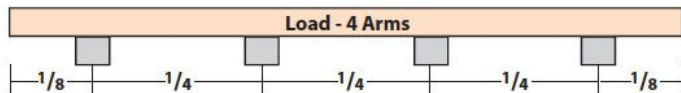
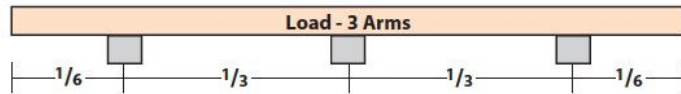
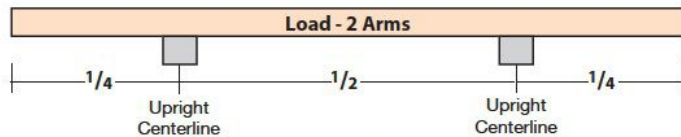
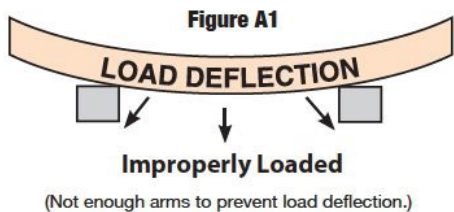

Figure A2

Figure A3

Figure A4

Adhering to these guidelines will ensure that each arm supports an equal amount of the load's weight.

B. DETERMINE THE LENGTH OF THE ARMS

The depth of the load should never exceed the length of the arm. A 48" wide bundle of plywood requires a 48" long arm, bundles of steel 24" wide require a 24" arm and so on. Rated

arm capacities may be seriously diminished if proper loading techniques are not observed. Figures B1, B2 and B3 illustrate correct and incorrect arm loading.

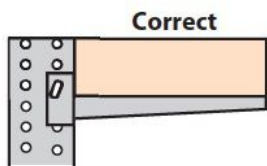

Figure B1

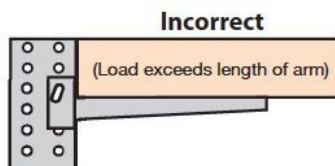

Figure B2

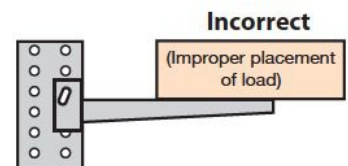

Figure B3

NOTE: All arm capacities are based on an evenly distributed load as in figures B4 and B5 below.

Evenly Distributed Load
(front to back)
Full rated arm capacity

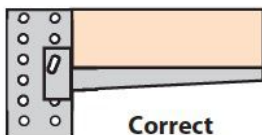

Figure B4

Centered Load
Full rated arm capacity

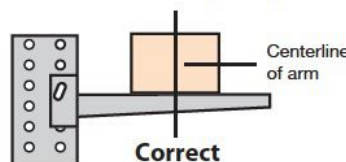

Figure B5

Tip Loading
Arm capacity may be reduced by up to 50%

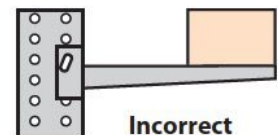

Figure B6

C. DETERMINE THE HEIGHT OF THE UPRIGHT

When determining the height of the upright, it is important to consider the ceiling height, forklift reach, sprinkler systems. Local building codes could also affect the overall height.

The height of the upright in figure C1 is determined by adding the base height, the number of loads to be stored, the arm thickness plus 6" clearance between the load and next arm. Contact your **MECO OMAHA** sales professional for various rack dimensions such as base height and arm thickness.

IMPORTANT: The load placed on the base does not diminish the rated capacity of the upright. Thus, the heaviest loads should be placed on the base.

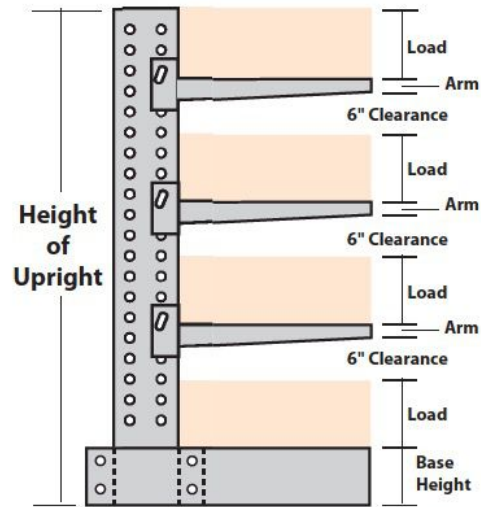

Figure C1

D. DETERMINE ARM AND UPRIGHT CAPACITIES

As previously discussed, each arm supports an equal amount of the load's weight. By determining the number of arms per level and dividing it into the weight per level, the required arm capacity can be determined (see example at right).

To determine the required capacity of each upright, multiply the number of arms per side by the load on each arm. In figure D1, each arm holds 2,500 lbs. Twelve arms per side times 2,500 lbs. per arm equals 30,000 lbs., which when divided by three uprights, results in a required minimum capacity of 10,000 lbs. per upright.

The correct upright can be selected by matching the minimum upright capacity of 10,000 lbs. with the upright capacities set forth on the following pages. Assuming a 48" arm, the U1061-NS on page 26 with 10,200 lbs. capacity, the U1061 on page 27 with 12,600 lbs. capacity and the XU1064 on page 28 with 17,700 lbs. capacity are the only uprights that will handle the load. **NOTE:** The Series 1000 MU1057 has only 3,100 lbs. capacity while the Series 2000 2U1062 has 8600 lbs. capacity.

The proper 48" arm (requiring 2,500 lbs. of capacity) can be found on page 28: either the XHDSA48 at 2,500 lbs. or the XHDSA483M at 3,000 lbs. capacity.

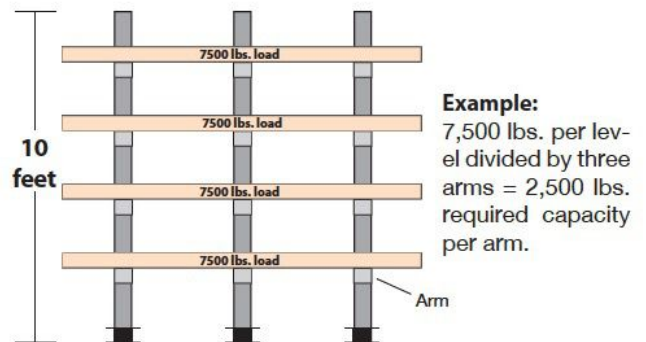

Figure D1

NOTE: Total arm capacity must never exceed total upright capacity.

E. DETERMINE BRACE LENGTH

Brace length is defined as the horizontal distance from centerline of upright to centerline of the next upright. Refer

to the various brace set charts for the brace length that most closely matches the arm spacing determined in step A.

The following pages set forth MECO OMAHA's wide range of cantilever racks – beginning with the Series 1000 Medium Duty on page 24 through the Series 5000 Extra Heavy Duty on page 28. MECO OMAHA representatives will work with you to develop the most feasible and economical rack system for your unique situation.



SERIES 1000 MEDIUM DUTY CANTILEVER RACK

EXCELLENT LOW COST STORAGE SYSTEM - IDEAL FOR MAINTENANCE DEPARTMENTS AND TOOL ROOMS

High quality **MECO OMAHA** Series 1000 Cantilever Rack is designed for use where heavier capacities are not required. This rack is similar to our popular heavier duty racks except for the use of lighter gauge steel and smaller dimensions of component parts. Available in 6', 7', 8', 10' and 12' single and double sided uprights with a choice of eight standard brace lengths (measured on center) to accommodate 12", 18", 24", 30", 36", 42" and 48" straight or inclined arms. Arms are completely adjustable on 3" centers up and down the full length of the uprights. Two or more uprights can be assembled into a continuous system.

This sturdy and stable rack is as convenient and versatile as the heavier duty racks but priced lower to reflect the reduced capacity. Installation is quick and easy. Racks can be tailored to your individual requirements. Uprights facilitate manual loading and unloading. Open base design affords easy forklift accessibility. Ideal for storing bar stock, pipe, tubing, lumber and many lightweight or hard-to-stock items that must be kept off the floor.



- EASY LOADING AND UNLOADING
- EVERY ITEM READILY AVAILABLE
- ALL WEIGHTS INCLUDE HARDWARE

MECO OMAHA SERIES 1000 UPRIGHTS, ARMS and BRACE SETS are not interchangeable with any other rack series.

SINGLE SIDED UPRIGHTS					
HEIGHT OF UPRIGHT	LENGTH OF BASE	LENGTH OF ARM	WEIGHT (LBS)	CAPACITY (LBS)	MODEL NO.
6'	33"	12" & 18"	83	8,100 & 6,600	MU633
	33"	24"	83	5,500	MU633
	45"	30" & 36"	92	4,700 & 4,100	MU645
	57"	42" & 48"	101	3,700 & 3,300	MU657
7'	33"	12" & 18"	90	7,900 & 6,400	MU733
	33"	24"	90	5,300	MU733
	45"	30" & 36"	99	4,600 & 4,100	MU745
	57"	42" & 48"	108	3,700 & 3,300	MU757
8'	33"	12" & 18"	97	7,600 & 6,300	MU833
	33"	24"	97	5,300	MU833
	45"	30" & 36"	106	4,500 & 4,000	MU845
	57"	42" & 48"	115	3,600 & 3,200	MU857
10'	33"	12" & 18"	111	7,100 & 5,900	MU1033
	33"	24"	111	5,000	MU1033
	45"	30"	120	4,400 & 3,800	MU1045
	57"	36" & 42" & 48"	129	3,400 & 3,100	MU1057
12'	33"	12" & 18"	126	6,500 & 5,400	MU1233
	33"	24"	126	4,700	MU1233
	45"	30" & 36"	135	4,100 & 3,700	MU1245
	57"	42" & 48"	144	3,300 & 3,000	MU1257

DOUBLE SIDED UPRIGHTS					
HEIGHT OF UPRIGHT	LENGTH OF BASE	LENGTH OF ARM	WEIGHT (LBS)	CAPACITY (LBS)	MODEL NO.
6'	54"	12" & 18"	102	16,200 & 13,200	MDU654
	54"	24"	102	11,000	MDU654
	78"	30" & 36"	120	9,400 & 8,200	MDU678
	102"	42" & 48"	138	7,400 & 6,600	MDU6102
7'	54"	12" & 18"	109	15,800 & 12,800	MDU754
	54"	24"	109	10,600	MDU754
	78"	30" & 36"	127	9,200 & 8,200	MDU778
	102"	42" & 48"	145	7,400 & 6,600	MDU7102
8'	54"	12" & 18"	116	15,200 & 12,600	MDU854
	54"	24"	116	10,600	MDU854
	78"	30" & 36"	134	9,000 & 8,000	MDU878
	102"	42" & 48"	152	7,200 & 6,400	MDU8102
10'	54"	12" & 18"	130	14,200 & 11,800	MDU1054
	54"	24"	130	10,000	MDU1054
	78"	30" & 36"	148	8,800 & 7,600	MDU1078
	102"	42" & 48"	166	6,800 & 6,200	MDU10102
12'	54"	12" & 18"	145	13,000 & 10,800	MDU1254
	54"	24"	145	9,400	MDU1254
	78"	30" & 36"	163	8,200 & 7,400	MDU1278
	102"	42" & 48"	181	6,600 & 6,000	MDU12102

STRAIGHT ARMS				
LENGTH	CAPACITY	WEIGHT	MODEL NO. WITHOUT LIP	MODEL NO. WITH LIP
12"	1000 lbs	5 lbs	MSA12	MSA12L
18"	750 lbs	7 lbs	MSA18	MSA18L
24"	600 lbs	8 lbs	MSA24	MSA24L
30"	500 lbs	9 lbs	MSA30	MSA30L
36"	400 lbs	10 lbs	MSA36	MSA36L
42"	350 lbs	12 lbs	MSA42	MSA42L
48"	300 lbs	13 lbs	MSA48	MSA48L

INCLINED ARMS				
LENGTH	CAPACITY	WEIGHT	MODEL NO. WITHOUT LIP	MODEL NO. WITH LIP
12"	1000 lbs	5 lbs	MIA12	MIA12L
18"	750 lbs	7 lbs	MIA18	MIA18L
24"	600 lbs	8 lbs	MIA24	MIA24L
30"	500 lbs	9 lbs	MIA30	MIA30L
36"	400 lbs	10 lbs	MIA36	MIA36L
42"	350 lbs	12 lbs	MIA42	MIA42L
48"	300 lbs	13 lbs	MIA48	MIA48L

STRAIGHT ARMS have a minimum pitch of 3/4" per foot to compensate for deflection. Arm capacities are based on an evenly distributed load.

INCLINED ARMS have a pitch of 20 degrees or approximately 4.36" per foot. Arm capacities are based on an evenly distributed load.

ARMS above can be used on **SERIES 1000** uprights only. Capacities are based on an evenly distributed load. Note that arm lips are not intended to bear any portion of the load.

LENGTH*	BRACES FOR 6' - 8' UPRIGHTS - SET OF TWO		BRACES FOR 10' - 12' UPRIGHTS - SET OF THREE	
	MODEL NO.	WEIGHT	MODEL NO.	WEIGHT
23"	M2B24	21 lbs	M3B24	31 lbs
35"	M2B36	28 lbs	M3B36	41 lbs
41"	M2B42	31 lbs	M3B42	47 lbs
47"	M2B48	35 lbs	M3B48	52 lbs
59"	M2B60	42 lbs	M3B60	62 lbs
71"	M2B72	49 lbs	M3B72	73 lbs
83"	M2B84	56 lbs	M3B84	83 lbs
95"	M2B96	63 lbs	M3B96	94 lbs

* Length of braces is measured from center of upright to center of upright.



SERIES 2000 MEDIUM-HEAVY DUTY CANTILEVER RACK

SINGLE SIDED UPRIGHTS					
HEIGHT OF UPRIGHT	LENGTH OF BASE	LENGTH OF ARM	WEIGHT (LBS)	CAPACITY (LBS)	MODEL NO.
6'	38"	12" & 18"	154	18,100 & 15,300	2U638
	38"	24"	154	13,300	2U638
	50"	30" & 36"	167	11,800 & 10,600	2U650
	62"	42" & 48"	180	9,600 & 8,800	2U662
8'	38"	12" & 18"	180	18,100 & 15,300	2U838
	38"	24"	180	13,300	2U838
	50"	30" & 36"	193	11,800 & 10,600	2U850
	62"	42" & 48"	206	9,600 & 8,800	2U862
10'	38"	12" & 18"	208	17,400 & 14,900	2U1038
	38"	24"	208	13,100	2U1038
	50"	30" & 36"	222	11,500 & 10,300	2U1050
	62"	42" & 48"	235	9,400 & 8,600	2U1062
12'	38"	12" & 18"	234	16,800 & 14,500	2U1238
	38"	24"	234	12,600	2U1238
	50"	30" & 36"	248	11,200 & 10,200	2U1250
	62"	42" & 48"	261	9,300 & 8,500	2U1262
14'	38"	12" & 18"	261	16,200 & 14,100	2U1438
	38"	24"	261	12,300	2U1438
	50"	30" & 36"	275	10,900 & 9,800	2U1450
	62"	42" & 48"	288	8,900 & 8,300	2U1462
16'	38"	12" & 18"	290	15,800 & 13,800	2U1638
	38"	24"	290	12,100	2U1638
	50"	30" & 36"	303	10,600 & 9,400	2U1650
	62"	42" & 48"	317	8,400 & 7,500	2U1662
18'	38"	12" & 18"	317	15,700 & 13,700	2U1838
	38"	24"	317	11,900	2U1838
	50"	30" & 36"	330	10,400 & 9,200	2U1850
	62"	42" & 48"	344	8,200 & 7,400	2U1862
20'	38"	12" & 18"	344	15,600 & 13,600	2U2038
	38"	24"	344	11,700	2U2038
	50"	30" & 36"	357	10,200 & 9,000	2U2050
	62"	42" & 48"	371	8,100 & 7,300	2U2062

DOUBLE SIDED UPRIGHTS					
HEIGHT OF UPRIGHT	LENGTH OF BASE	LENGTH OF ARM	WEIGHT (LBS)	CAPACITY (LBS)	MODEL NO.
6'	59"	12" & 18"	182	36,200 & 30,600	2DU659
	59"	24"	182	26,600	2DU659
	83"	30" & 36"	209	23,600 & 21,200	2DU683
	107"	42" & 48"	236	19,200 & 17,600	2DU6107
8'	59"	12" & 18"	208	36,200 & 30,600	2DU859
	59"	24"	208	26,600	2DU859
	83"	30" & 36"	235	23,600 & 21,200	2DU883
	107"	42" & 48"	262	19,200 & 17,600	2DU8107
10'	59"	12" & 18"	237	34,800 & 29,800	2DU1059
	59"	24"	237	26,200	2DU1059
	83"	30" & 36"	264	23,000 & 20,600	2DU1083
	107"	42" & 48"	291	18,800 & 17,200	2DU10107
12'	59"	12" & 18"	263	33,600 & 29,000	2DU1259
	59"	24"	263	25,200	2DU1259
	83"	30" & 36"	290	22,400 & 20,400	2DU1283
	107"	42" & 48"	317	18,600 & 17,000	2DU12107
14'	59"	12" & 18"	290	32,400 & 28,200	2DU1459
	59"	24"	290	24,600	2DU1459
	83"	30" & 36"	317	21,800 & 19,600	2DU1483
	107"	42" & 48"	344	17,800 & 16,600	2DU14107
16'	59"	12" & 18"	318	31,600 & 27,600	2DU1659
	59"	24"	318	24,200	2DU1659
	83"	30" & 36"	345	21,200 & 18,800	2DU1683
	107"	42" & 48"	372	16,800 & 15,000	2DU16107
18'	59"	12" & 18"	345	31,400 & 27,400	2DU1859
	59"	24"	345	23,800	2DU1859
	83"	30" & 36"	372	20,800 & 18,400	2DU1883
	107"	42" & 48"	399	16,400 & 14,800	2DU18107
20'	59"	12" & 18"	372	31,200 & 27,200	2DU2059
	59"	24"	372	23,400	2DU2059
	83"	30" & 36"	399	20,400 & 18,000	2DU2083
	107"	42" & 48"	426	16,200 & 14,600	2DU20107

MECO OMAHA SERIES 2000 UPRIGHTS, ARMS and BRACE SETS are not interchangeable with any other rack series.

ARMS below can be used on SERIES 2000 uprights only. Capacities are based on an evenly distributed load. Note that arm lips are not intended to bear any portion of the load.

STRAIGHT ARMS				
LENGTH	CAPACITY	WEIGHT	MODEL NO. WITHOUT LIP	MODEL NO. WITH LIP
12"	2,000 lbs	7 lbs	2SA12	2SA12L
18"	1,500 lbs	8 lbs	2SA18	2SA18L
24"	1,200 lbs	10 lbs	2SA24	2SA24L
30"	1,000 lbs	12 lbs	2SA30	2SA30L
36"	800 lbs	13 lbs	2SA36	2SA36L
42"	700 lbs	15 lbs	2SA42	2SA42L
48"	600 lbs	17 lbs	2SA48	2SA48L
INCLINED ARMS				
12"	2,000 lbs	7 lbs	2IA12	2IA12L
18"	1,500 lbs	8 lbs	2IA18	2IA18L
24"	1,200 lbs	10 lbs	2IA24	2IA24L
30"	1,000 lbs	12 lbs	2IA30	2IA30L
36"	800 lbs	13 lbs	2IA36	2IA36L
42"	700 lbs	15 lbs	2IA42	2IA42L
48"	600 lbs	17 lbs	2IA48	2IA48L

HEAVY DUTY AND EXTRA HEAVY DUTY STRAIGHT ARMS				
LENGTH	CAPACITY	WEIGHT	MODEL NO. WITHOUT LIP	MODEL NO. WITH LIP
24"	2,400 lbs	14 lbs	2HDSA24	2HDSA24L
30"	2,000 lbs	16 lbs	2HDSA30	2HDSA30L
36"	1,500 lbs	18 lbs	2HDSA36	2HDSA36L
	2,400 lbs	22 lbs	2XHDSA36	2XHDSA36L
42"	1,400 lbs	21 lbs	2HDSA42	2HDSA42L
	2,400 lbs	25 lbs	2XHDSA42	2XHDSA42L
48"	1,000 lbs	21 lbs	2HDSA481M	2HDSA481M
	1,500 lbs	23 lbs	2HDSA48	2HDSA48L
	2,000 lbs	23 lbs	2XHDSA48	2XHDSA48L

STRAIGHT ARMS have a minimum pitch of 3/8" per foot to compensate for deflection. Arm capacities are based on an evenly distributed load.

INCLINED ARMS have a pitch of 20 degrees or approximately 4.36" per foot. Arm capacities are based on an evenly distributed load.

LENGTH*	BRACES FOR 8' UPRIGHTS – SET OF TWO		BRACES FOR 10' - 14' UPRIGHTS – SET OF THREE		BRACES FOR 16' - 20' UPRIGHTS – SET OF FOUR INCLUDING X-BRACING	
	MODEL NO.	WEIGHT	MODEL NO.	WEIGHT	MODEL NO.	WEIGHT
23"	22B24	21 lbs	23B24	31 lbs	24B24X	65 lbs
35"	22B36	28 lbs	23B36	41 lbs	24B36X	80 lbs
41"	22B42	31 lbs	23B42	47 lbs	24B42X	88 lbs
47"	22B48	35 lbs	23B48	52 lbs	24B48X	96 lbs
59"	22B60	42 lbs	23B60	62 lbs	24B60X	113 lbs
71"	22B72	49 lbs	23B72	73 lbs	24B72X	130 lbs
83"	22B84	56 lbs	23B84	83 lbs	24B84X	147 lbs
95"	22B96	63 lbs	23B96	94 lbs	24B96XX	181 lbs
119"	22B120	113 lbs	23B120	170 lbs	24B120XX	282 lbs

* Length of braces is measured from center of upright to center of upright.

ALL WEIGHTS INCLUDE HARDWARE



OMAHA

CANTILEVER RACK

**SERIES 3000 HEAVY DUTY CANTILEVER RACK
UPRIGHTS**

FOR YOUR NORMAL INDUSTRIAL STORAGE REQUIREMENTS

A MECO OMAHA rack system can be specifically designed to meet your individual requirements. MECO OMAHA representatives will work with you to develop the most feasible and economical rack system for your special situation.

SINGLE SIDED UPRIGHTS						DOUBLE SIDED UPRIGHTS					
HEIGHT OF UPRIGHT	LENGTH OF BASE	LENGTH OF ARM	WEIGHT (LBS)	CAPACITY (LBS)	MODEL NO.	HEIGHT OF UPRIGHT	LENGTH OF BASE	LENGTH OF ARM	WEIGHT (LBS)	CAPACITY (LBS)	MODEL NO.
6'	31"	12" & 18"	186	23,000 & 19,200	U631-NS	6'	53"	12" & 18"	224	46,000 & 38,400	DU653-NS
	37"	24"	195	16,500	U637-NS		65"	24"	242	33,000	DU665-NS
	49"	30" & 36"	212	14,400 & 12,800	U649-NS		82"	30" & 36"	267	28,800 & 25,600	DU682-NS
	61"	42" & 48"	230	11,500 & 10,400	U661-NS		106"	42" & 48"	302	23,000 & 20,800	DU6106-NS
	74"	54" & 60"	249	9,600 & 8,800	U674-NS		130"	54" & 60"	338	19,200 & 17,600	DU6130-NS
8'	31"	12" & 18"	221	23,000 & 19,200	U831-NS	8'	53"	12" & 18"	259	46,000 & 38,400	DU853-NS
	37"	24"	230	16,500	U837-NS		65"	24"	277	33,000	DU865-NS
	49"	30" & 36"	247	14,400 & 12,800	U849-NS		82"	30" & 36"	302	28,800 & 25,600	DU882-NS
	61"	42" & 48"	265	11,500 & 10,400	U861-NS		106"	42" & 48"	337	23,000 & 20,800	DU8106-NS
	74"	54" & 60"	284	9,600 & 8,800	U874-NS		130"	54" & 60"	373	19,200 & 17,600	DU8130-NS
10'	31"	12" & 18"	258	22,200 & 18,600	U1031-NS	10'	53"	12" & 18"	296	44,400 & 37,200	DU1053-NS
	37"	24"	267	16,100	U1037-NS		65"	24"	316	32,200	DU1065-NS
	49"	30" & 36"	284	14,100 & 12,500	U1049-NS		82"	30" & 36"	339	28,200 & 25,000	DU1082-NS
	61"	42" & 48"	302	11,300 & 10,200	U1061-NS		106"	42" & 48"	374	22,600 & 20,400	DU10106-NS
	74"	54" & 60"	321	9,400 & 8,700	U1074-NS		130"	54" & 60"	410	18,800 & 17,400	DU10130-NS
12'	31"	12" & 18"	293	21,300 & 18,000	U1231-NS	12'	53"	12" & 18"	331	42,600 & 36,000	DU1253-NS
	37"	24"	302	15,600	U1237-NS		65"	24"	351	31,200	DU1265-NS
	49"	30" & 36"	319	13,700 & 12,200	U1249-NS		82"	30" & 36"	374	27,400 & 24,400	DU1282-NS
	61"	42" & 48"	337	11,000 & 10,100	U1261-NS		106"	42" & 48"	409	22,000 & 20,200	DU12106-NS
	74"	54" & 60"	356	9,200 & 8,600	U1274-NS		130"	54" & 60"	445	18,400 & 17,200	DU12130-NS
14'	37"	12" & 18"	336	20,500 & 17,400	U1437-NS	14'	65"	12" & 18"	385	41,000 & 34,800	DU1465-NS
	37"	24"	336	15,100	U1437-NS		65"	24"	385	30,200	DU1465-NS
	49"	30" & 36"	353	13,300 & 11,800	U1449-NS		82"	30" & 36"	408	26,600 & 23,600	DU1482-NS
	61"	42" & 48"	371	10,700 & 9,800	U1461-NS		106"	42" & 48"	443	21,400 & 19,600	DU14106-NS
	74"	54" & 60"	390	9,000 & 8,300	U1474-NS		130"	54" & 60"	479	18,000 & 16,600	DU14130-NS
15'	37"	12" & 18"	357	20,000 & 17,100	U1537-NS	15'	65"	12" & 18"	406	40,000 & 34,200	DU1565-NS
	37"	24"	357	14,800	U1537-NS		65"	24"	406	29,600	DU1565-NS
	49"	30" & 36"	374	13,200 & 11,600	U1549-NS		82"	30" & 36"	429	26,400 & 23,200	DU1582-NS
	61"	42" & 48"	392	10,500 & 9,700	U1561-NS		106"	42" & 48"	464	21,000 & 19,400	DU15106-NS
	74"	54" & 60"	411	8,900 & 8,300	U1574-NS		130"	54" & 60"	500	17,800 & 16,600	DU15130-NS
16'	37"	12" & 18"	375	19,300 & 16,600	U1637-NS	16'	65"	12" & 18"	424	38,600 & 33,200	DU1665-NS
	37"	24"	375	14,400	U1637-NS		65"	24"	424	28,800	DU1665-NS
	49"	30" & 36"	392	12,800 & 11,300	U1649-NS		82"	30" & 36"	447	25,600 & 22,600	DU1682-NS
	61"	42" & 48"	410	10,400 & 9,500	U1661-NS		106"	42" & 48"	482	20,800 & 19,000	DU16106-NS
	74"	54" & 60"	429	8,800 & 8,200	U1674-NS		130"	54" & 60"	518	17,600 & 16,400	DU16130-NS
18'	49"	12" & 18"	427	18,200 & 15,600	U1849-NS	18'	82"	12" & 18"	482	36,400 & 31,200	DU1882-NS
	49"	24" & 30"	427	13,800 & 12,300	U1849-NS		82"	24" & 30"	482	27,600 & 24,600	DU1882-NS
	49"	36"	427	10,800	U1849-NS		82"	36"	482	21,600	DU1882-NS
	61"	42" & 48"	445	9,900 & 9,200	U1861-NS		106"	42" & 48"	517	19,800 & 18,400	DU18106-NS
	74"	54" & 60"	464	8,500 & 8,000	U1874-NS		130"	54" & 60"	553	17,000 & 16,000	DU18130-NS
20'	49"	12" & 18"	462	16,700 & 14,600	U2049-NS	20'	82"	12" & 18"	517	33,400 & 29,200	DU2082-NS
	49"	24" & 30"	462	12,900 & 11,700	U2049-NS		82"	24" & 30"	517	25,800 & 23,400	DU2082-NS
	49"	36"	462	10,400	U2049-NS		82"	36"	517	20,800	DU2082-NS
	61"	42" & 48"	480	9,400 & 8,800	U2061-NS		106"	42" & 48"	552	18,800 & 17,600	DU20106-NS
	74"	54" & 60"	499	8,100 & 7,600	U2074-NS		130"	54" & 60"	588	16,200 & 15,200	DU20130-NS

BRACE SETS

All braces below can be used on SERIES 3000, SERIES 4000 or SERIES 5000 uprights only.



LENGTH*	FOR 8' UPRIGHTS SET OF TWO		FOR 10' - 14' UPRIGHTS SET OF THREE		FOR 15' - 20' UPRIGHTS SET OF FOUR INCLUDING X-BRACING	
	MODEL NO.	WEIGHT	MODEL NO.	WEIGHT	MODEL NO.	WEIGHT
24"	2B24	21 lbs	3B24	31 lbs	4B24X	65 lbs
36"	2B36	28 lbs	3B36	41 lbs	4B36X	80 lbs
42"	2B42	31 lbs	3B42	47 lbs	4B42X	88 lbs
48"	2B48	35 lbs	3B48	52 lbs	4B48X	96 lbs
60"	2B60	42 lbs	3B60	62 lbs	4B60X	113 lbs
72"	2B72	49 lbs	3B72	73 lbs	4B72X	130 lbs
84"	2B84	56 lbs	3B84	83 lbs	4B84X	147 lbs
96"	2B96	63 lbs	3B96	94 lbs	4B96XX	181 lbs
120"	2B120	113 lbs	3B120	170 lbs	4B120XX	282 lbs



*Length of braces is measured from center of upright to center of upright.

ALL WEIGHTS INCLUDE HARDWARE



SERIES 4000 STANDARD HEAVY DUTY CANTILEVER RACK UPRIGHTS

FOR YOUR NORMAL HEAVY DUTY INDUSTRIAL STORAGE REQUIREMENTS

SINGLE SIDED UPRIGHTS						DOUBLE SIDED UPRIGHTS					
HEIGHT OF UPRIGHT	LENGTH OF BASE	LENGTH OF ARM	WEIGHT (LBS)	CAPACITY (LBS)	MODEL NO.	HEIGHT OF UPRIGHT	LENGTH OF BASE	LENGTH OF ARM	WEIGHT (LBS)	CAPACITY (LBS)	MODEL NO.
6'	31"	12" & 18"	207	28,600 & 24,700	U631	6'	53"	12" & 18"	245	57,200 & 49,400	DU653
	37"	24"	216	21,500	U637		65"	24"	263	43,000	DU665
	49"	30" & 36"	233	18,300 & 16,000	U649		82"	30" & 36"	288	36,600 & 32,000	DU682
	61"	42" & 48"	251	14,200 & 12,800	U661		106"	42" & 48"	323	28,400 & 25,600	DU6106
	74"	54" & 60"	270	11,600 & 10,700	U674		130"	54" & 60"	359	23,200 & 21,400	DU6130
8'	31"	12" & 18"	242	28,600 & 24,700	U831	8'	53"	12" & 18"	280	57,200 & 49,400	DU853
	37"	24"	251	21,500	U837		65"	24"	298	43,000	DU865
	49"	30" & 36"	268	18,300 & 16,000	U849		82"	30" & 36"	323	36,600 & 32,000	DU882
	61"	42" & 48"	286	14,200 & 12,800	U861		106"	42" & 48"	358	28,400 & 25,600	DU8106
	74"	54" & 60"	305	11,600 & 10,700	U874		130"	54" & 60"	394	23,200 & 21,400	DU8130
10'	31"	12" & 18"	279	28,500 & 24,600	U1031	10'	53"	12" & 18"	317	57,000 & 49,200	DU1053
	37"	24"	288	21,300	U1037		65"	24"	337	42,600	DU1065
	49"	30" & 36"	305	18,200 & 15,800	U1049		82"	30" & 36"	360	36,400 & 31,600	DU1082
	61"	42" & 48"	323	14,100 & 12,600	U1061		106"	42" & 48"	395	28,200 & 25,200	DU10106
	74"	54" & 60"	342	11,500 & 10,600	U1074		130"	54" & 60"	431	23,000 & 21,200	DU10130
12'	31"	12" & 18"	314	28,200 & 24,400	U1231	12'	53"	12" & 18"	348	56,400 & 48,800	DU1253
	37"	24"	323	20,900	U1237		65"	24"	372	41,800	DU1265
	49"	30" & 36"	340	17,800 & 15,600	U1249		82"	30" & 36"	395	35,600 & 31,200	DU1282
	61"	42" & 48"	358	13,900 & 12,500	U1261		106"	42" & 48"	430	27,800 & 25,000	DU12106
	74"	54" & 60"	377	11,400 & 10,500	U1274		130"	54" & 60"	466	22,800 & 21,000	DU12130
14'	37"	12" & 18"	357	27,400 & 23,400	U1437	14'	65"	12" & 18"	406	54,800 & 46,800	DU1465
	37"	24"	357	20,200	U1437		65"	24"	406	40,400	DU1465
	49"	30" & 36"	374	17,600 & 15,400	U1449		82"	30" & 36"	429	35,200 & 30,800	DU1482
	61"	42" & 48"	392	13,700 & 12,400	U1461		106"	42" & 48"	464	27,400 & 24,800	DU14106
	74"	54" & 60"	411	11,300 & 10,400	U1474		130"	54" & 60"	500	22,600 & 20,800	DU14130
15'	37"	12" & 18"	378	27,100 & 22,600	U1537	15'	65"	12" & 18"	427	54,200 & 45,200	DU1565
	37"	24"	378	19,200	U1537		65"	24"	427	38,400	DU1565
	49"	30" & 36"	395	16,900 & 15,000	U1549		82"	30" & 36"	450	33,800 & 30,000	DU1582
	61"	42" & 48"	413	13,600 & 12,300	U1561		106"	42" & 48"	485	27,200 & 24,600	DU15106
	74"	54" & 60"	432	11,200 & 10,300	U1574		130"	54" & 60"	521	22,400 & 20,600	DU15130
16'	37"	12" & 18"	396	23,700 & 20,300	U1637	16'	65"	12" & 18"	445	47,400 & 40,600	DU1665
	37"	24"	396	17,600	U1637		65"	24"	445	35,200	DU1665
	49"	30" & 36"	413	15,300 & 14,000	U1649		82"	30" & 36"	468	30,600 & 28,000	DU1682
	61"	42" & 48"	431	12,900 & 12,000	U1661		106"	42" & 48"	503	25,800 & 24,000	DU16106
	74"	54" & 60"	450	11,100 & 10,300	U1674		130"	54" & 60"	539	22,200 & 20,600	DU16130
18'	49"	12" & 18"	448	22,200 & 19,200	U1849	18'	82"	12" & 18"	503	44,400 & 38,400	DU1882
	49"	24" & 30"	448	16,700 & 14,700	U1849		82"	24" & 30"	503	33,400 & 29,400	DU1882
	49"	36"	448	13,600	U1849		82"	36"	503	27,200	DU1882
	61"	42" & 48"	466	12,700 & 11,900	U1861		106"	42" & 48"	538	25,400 & 23,800	DU18106
	74"	54" & 60"	485	11,000 & 10,000	U1874		130"	54" & 60"	574	22,000 & 20,000	DU18130
20'	49"	12" & 18"	483	20,600 & 17,800	U2049	20'	82"	12" & 18"	538	41,200 & 35,600	DU2082
	49"	24" & 30"	483	15,800 & 13,900	U2049		82"	24" & 30"	538	31,600 & 27,800	DU2082
	49"	36"	483	12,800	U2049		82"	36"	538	25,600	DU2082
	61"	42" & 48"	501	11,900 & 11,200	U2061		106"	42" & 48"	573	23,800 & 22,400	DU20106
	74"	54" & 60"	520	10,500 & 9,800	U2074		130"	54" & 60"	609	21,000 & 19,600	DU20130

A MECO OMAHA rack system can be specifically designed to meet your individual requirements. MECO OMAHA representatives will work with you to develop the most feasible and economical rack system for your special situation.

ARMS below can be used on SERIES 3000, SERIES 4000 or SERIES 5000 uprights only. Capacities are based on an evenly distributed load. Note that arm lips are not intended to bear any portion of the load.

STANDARD STRAIGHT ARMS				
LENGTH	CAPACITY	WEIGHT	MODEL NO. WITHOUT LIP	MODEL NO. WITH LIP
12"	3000 lbs	10 lbs	SA12	SA12L
18"	2500 lbs	12 lbs	SA18	SA18L
24"	2000 lbs	14 lbs	SA24	SA24L
30"	1500 lbs	17 lbs	SA30	SA30L
36"	1200 lbs	19 lbs	SA36	SA36L
42"	1100 lbs	21 lbs	SA42	SA42L
48"	1000 lbs	23 lbs	SA48	SA48L
54"	800 lbs	26 lbs	SA54	SA54L
60"	600 lbs	28 lbs	SA60	SA60L

STRAIGHT ARMS through 48" long have a minimum pitch of 3/8" per foot to compensate for deflection. 54" and 60" arms have a minimum pitch of 5/8" per foot.

STANDARD INCLINED ARMS				
LENGTH	CAPACITY	WEIGHT	MODEL NO. WITHOUT LIP	MODEL NO. WITH LIP
12"	3000 lbs	10 lbs	IA12	IA12L
18"	2500 lbs	13 lbs	IA18	IA18L
24"	2000 lbs	15 lbs	IA24	IA24L
30"	1500 lbs	17 lbs	IA30	IA30L
36"	1200 lbs	20 lbs	IA36	IA36L
42"	1100 lbs	22 lbs	IA42	IA42L
48"	1000 lbs	25 lbs	IA48	IA48L

INCLINED ARMS have a pitch of 20 degrees or approximately 4.36" per foot.

ALL WEIGHTS INCLUDE HARDWARE

See page 28 for
Heavy Duty and
Extra Heavy Duty
Straight Arms for
use with uprights
on pages 26
and 27.

SERIES 5000 EXTRA HEAVY DUTY CANTILEVER RACK UPRIGHTS

FOR STORAGE REQUIREMENTS WHICH DEMAND HEAVIER CAPACITY RACKS

MECO OMAHA SERIES 5000 CANTILEVER RACK solves your extra heavy duty storage problems and easily handles your toughest storage requirements. Contact your MECO OMAHA representative for your special storage needs.

SINGLE SIDED UPRIGHTS					
HEIGHT OF UPRIGHT	LENGTH OF BASE	LENGTH OF ARM	WEIGHT (LBS)	CAPACITY (LBS)	MODEL NO.
10'	40"	24"	367	28,700	XU1040
	52"	30" & 36"	388	24,800 & 21,900	XU1052
	64"	42" & 48"	410	19,600 & 17,700	XU1064
	76"	54" & 60"	431	16,100 & 14,900	XU1076
12'	40"	24"	409	28,700	XU1240
	52"	30" & 36"	430	24,800 & 21,900	XU1252
	64"	42" & 48"	452	19,600 & 17,700	XU1264
	76"	54" & 60"	473	16,100 & 14,900	XU1276
14'	40"	24"	451	28,400	XU1440
	52"	30" & 36"	472	24,700 & 21,000	XU1452
	64"	42" & 48"	494	19,100 & 17,600	XU1464
	76"	54" & 60"	515	16,000 & 14,600	XU1476
15'	52"	24"	495	28,200	XU1552
	52"	30" & 36"	495	22,600 & 20,700	XU1552
	64"	42" & 48"	517	18,900 & 17,400	XU1564
	76"	54" & 60"	538	15,900 & 14,500	XU1576
16'	52"	24"	516	27,600	XU1652
	52"	30" & 36"	516	24,300 & 20,500	XU1652
	64"	42" & 48"	538	18,700 & 17,200	XU1664
	76"	54" & 60"	559	15,700 & 14,400	XU1676
18'	52"	24"	558	25,900	XU1852
	52"	30" & 36"	558	23,100 & 20,400	XU1852
	64"	42" & 48"	580	18,200 & 16,800	XU1864
	76"	54" & 60"	601	15,300 & 14,100	XU1876
20'	52"	24"	601	25,300	XU2052
	52"	30" & 36"	601	21,800 & 19,700	XU2052
	64"	42" & 48"	623	17,600 & 16,300	XU2064
	76"	54" & 60"	644	14,900 & 13,800	XU2076

DOUBLE SIDED UPRIGHTS					
HEIGHT OF UPRIGHT	LENGTH OF BASE	LENGTH OF ARM	WEIGHT (LBS)	CAPACITY (LBS)	MODEL NO.
10'	66"	24"	420	57,400	XDU1066
	84"	30" & 36"	452	49,600 & 43,800	XDU1084
	108"	42" & 48"	494	39,200 & 35,400	XDU10108
	132"	54" & 60"	537	32,200 & 29,800	XDU10132
12'	66"	24"	462	57,400	XDU1266
	84"	30" & 36"	494	49,600 & 43,800	XDU1284
	108"	42" & 48"	536	39,200 & 35,400	XDU12108
	132"	54" & 60"	579	32,200 & 29,800	XDU12132
14'	66"	24"	504	56,800	XDU1466
	84"	30" & 36"	636	49,400 & 42,000	XDU1484
	108"	42" & 48"	578	38,200 & 35,200	XDU14108
	132"	54" & 60"	621	32,000 & 29,200	XDU14132
15'	84"	24"	559	56,400	XDU1584
	84"	30" & 36"	559	45,200 & 41,400	XDU1584
	108"	42" & 48"	601	37,800 & 34,800	XDU15108
	132"	54" & 60"	644	31,800 & 29,000	XDU15132
16'	84"	24"	580	55,200	XDU1684
	84"	30" & 36"	580	48,600 & 41,000	XDU1684
	108"	42" & 48"	622	37,400 & 34,400	XDU16108
	132"	54" & 60"	665	31,400 & 28,800	XDU16132
18'	84"	24"	622	51,800	XDU1884
	84"	30" & 36"	622	46,200 & 40,800	XDU1884
	108"	42" & 48"	664	36,400 & 33,600	XDU18108
	132"	54" & 60"	707	30,600 & 28,200	XDU18132
20'	84"	24"	665	50,600	XDU2084
	84"	30" & 36"	665	43,600 & 39,400	XDU2084
	108"	42" & 48"	707	35,200 & 32,600	XDU20108
	132"	54" & 60"	750	29,800 & 27,600	XDU20132

ARMS below can be used on SERIES 3000, SERIES 4000 or SERIES 5000 uprights only. Capacities are based on an evenly distributed load. Note that arm lips are not intended to bear any portion of the load.

HEAVY DUTY AND EXTRA HEAVY DUTY STRAIGHT ARMS					
LENGTH	CAPACITY	WEIGHT	MODEL NO. WITHOUT LIP	MODEL NO. WITH LIP	
36"	2,175 lbs	29 lbs	HDSA36	HDSA36L	
	3,400 lbs	34 lbs	XHDSA36	XHDSA36L	
42"	1,865 lbs	32 lbs	HDSA42	HDSA42L	
	2,900 lbs	37 lbs	XHDSA42	XHDSA42L	
48"	2,000 lbs	35 lbs	HDSA48	HDSA48L	
	2,500 lbs	40 lbs	XHDSA48	XHDSA48L	
	3,000 lbs	39 lbs	XHDSA483M	XHDSA48L3M	
54"	1,440 lbs	39 lbs	HDSA54	HDSA54L	
	2,000 lbs	44 lbs	XHDSA54	XHDSA54L	
60"	1,300 lbs	42 lbs	HDSA60	HDSA60L	
	1,650 lbs	45 lbs	XHDSA60	XHDSA60L	
	2,000 lbs	61 lbs	XHDSA602M	XHDSA60L2M	

See pages 26 and 27 for Brace Sets, Standard Straight Arms and Standard Inclined Arms for use with Series 5000 uprights.



Double Sided Uprights



CANTILEVER RACK STARTER AND ADD-ON UNITS

A COMPLETE STORAGE SYSTEM DESIGNED WITH FLEXIBILITY AND SIMPLICITY IN MIND

MECO OMAHA has assembled the most popular Series 1000 and Series 4000 cantilever components to create Starter and Add-On units—take the guesswork out of selecting a rack system! Order a single or double sided starter unit consisting of 2 uprights, straight arms and braces to assemble a single bay storage unit.

Create a continuous rack system with add-on units which include 1 Series 1000 or Series 4000 upright, straight arms and the appropriate brace set. Series 1000 models are available in upright heights of 6', 8' or 10' while Series 4000 models are available in upright heights of 8', 10' or 12'.

SERIES 1000 MEDIUM DUTY CANTILEVER RACK							
STARTER UNITS <i>INCLUDES: 2 UPRIGHTS, STRAIGHT ARMS, 1 BRACE SET (47" BRACE SET FOR 6' AND 8' UPRIGHTS, 71" BRACE SET FOR 10' UPRIGHTS)</i>				ADD-ON UNITS <i>INCLUDES: 1 UPRIGHT, STRAIGHT ARMS, 1 BRACE SET (47" BRACE SET FOR 6' AND 8' UPRIGHTS, 71" BRACE SET FOR 10' UPRIGHTS)</i>			
MODEL NO.	UPRIGHT		BASE	ARMS*			WEIGHT (LBS)
	HEIGHT (FT)	CAPACITY (LBS)	LENGTH (IN)	LENGTH (IN)	QUANTITY	CAPACITY (LBS)	
SINGLE SIDED UNITS							
SM6	6	8,100	33	12	6	1,000	230
SM8	8	5,300	33	24	8	600	290
SM10	10	3,800	45	36	12	400	438
DOUBLE SIDED UNITS							
SMD6	6	16,200	54	12	12	1,000	296
SMD8	8	10,600	54	24	16	600	387
SMD10	10	7,600	78	36	24	400	617

*Add Suffix "L" to Model Number for Arms with Lips.

SERIES 4000 STANDARD HEAVY DUTY CANTILEVER RACK							
STARTER UNITS <i>INCLUDES: 2 UPRIGHTS, STRAIGHT ARMS, 6" BRACE SET</i>				ADD-ON UNITS <i>INCLUDES: 1 UPRIGHT, STRAIGHT ARMS, 6" BRACE SET</i>			
MODEL NO.	UPRIGHT		BASE	ARMS*			WEIGHT (LBS)
	HEIGHT (FT)	CAPACITY (LBS)	LENGTH (IN)	LENGTH (IN)	QUANTITY	CAPACITY (LBS)	
SINGLE SIDED UNITS							
SU8	8	21,500	37	24	8	2,000	671
SU10	10	15,800	49	36	12	1,200	919
SU12	12	12,500	61	48	16	1,000	1,174
DOUBLE SIDED UNITS							
SDU8	8	43,000	65	24	16	2,000	887
SDU10	10	31,600	82	36	24	1,200	1,264
SDU12	12	25,000	106	48	32	1,000	1,704

* Add Suffix "L" to Model Number for Arms with Lips.

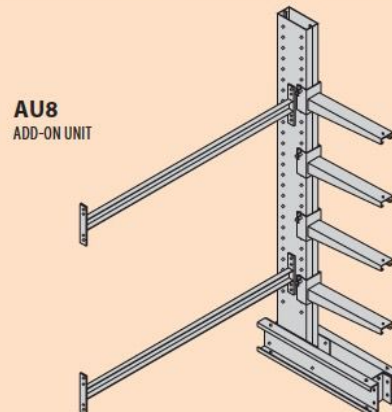
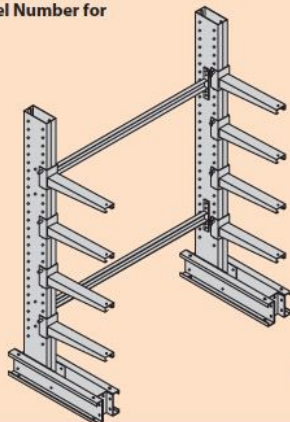

CANTILEVER RACK ACCESSORIES

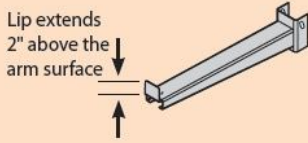

Bolt-On Arm Lips

All MECO OMAHA cantilever arms are factory punched to accept a bolt-on lip at any time. Lips can also be removed when they are no longer required. Lips are not intended to bear any portion of the load.

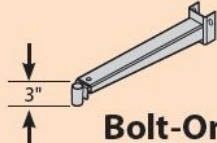

Bolt-On Pipe Sockets

Pipe sockets can be field installed or removed as needs dictate—just like bolt-on lips. Inside diameter of the socket is 1 3/8". Removable pipe is not included. Pipe sockets are not intended to bear any portion of the load.

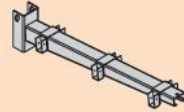

Drop-In Deck Support Saddles

Add a plywood deck to the cantilever system to store bulky items such as boxes, cartons and furniture. MECO OMAHA will pre-engineer the saddles to accommodate 2x4 cross supports. Saddles must be positioned along the arm to ensure equal distribution of weight. Deck support saddles can also be provided for the bases. Saddles must be fastened to the arms and bases. Field drilling is required. Fasteners are not included. Other saddle styles available. Please inquire.

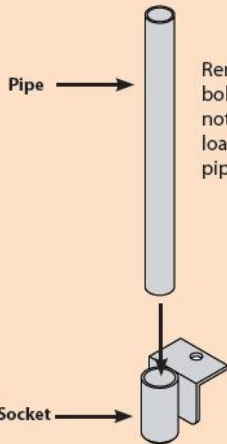

Pipe

Removable pipe used in conjunction with bolt-on pipe sockets. Pipe and socket are not intended to bear any portion of the load. Standard sizes include 6", 9" and 12" pipe.

Steel Decks

MECO OMAHA offers optional steel decks to withstand the harshest industrial environment. Ideal for storage of short lengths of material, dies, castings and other items that require an uninterrupted length of heavy duty decking. Steel angles are welded to the underside of the deck for additional strength. Arms and decks are precision drilled to accept mounting hardware.

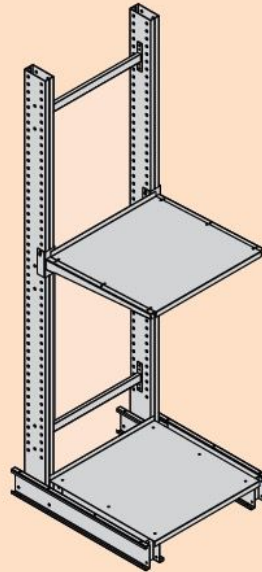

Roof Supports

Turn your MECO OMAHA cantilever rack system into covered storage with roof supports. Can be used as single or double sided roof (depending on length of base used). Purlin clips included. **NOTE:** The use of roof supports can significantly reduce the rack's capacity due to wind and snow loads. MECO OMAHA will custom design the roof supports to conform with local wind and snow load conditions.

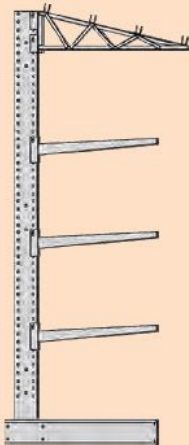

Single Sided

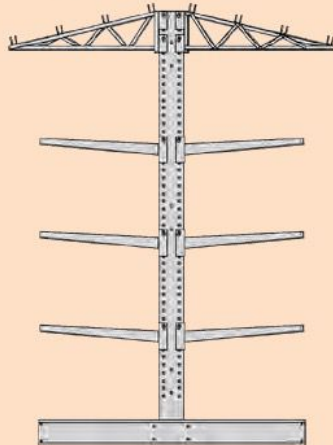

Double Sided

